

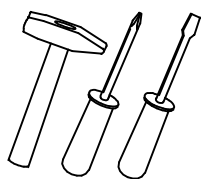

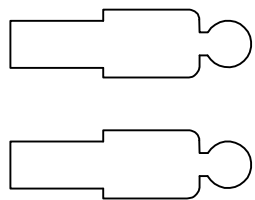

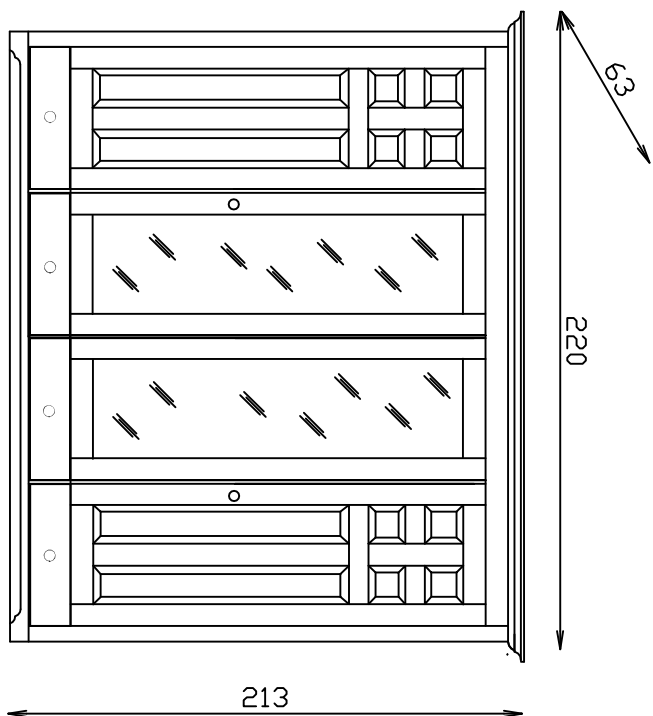





















# EDENBERG 4



	$\frac{A}{54x}$		$\frac{K}{8x}$		$\frac{S}{16x}$
	$\frac{B}{27x}$		$\frac{L}{2x}$		$\frac{T}{4x}$
	$\frac{C}{6x}$		$\frac{M}{8x}$		$\frac{U}{2x}$
	$\frac{D}{39x}$		$\frac{N}{38x}$		$\frac{W}{8x}$
	$\frac{E}{8x}$		$\frac{O}{8x}$		$\frac{X}{4x}$
	$\frac{F}{12x}$		$\frac{P}{8x}$		$\frac{Y}{2x}$
	$\frac{G}{12x}$		$\frac{Q}{8x}$		$\frac{Z}{18x}$
	$\frac{H}{2x}$		$\frac{R}{8x}$		$\frac{1}{1x}$
	$\frac{J}{8x}$				

# EDENBERG 4

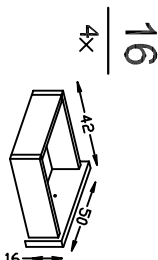
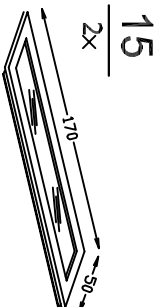
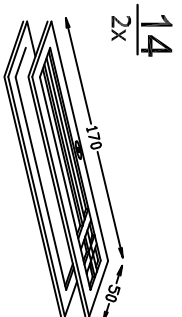
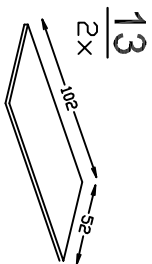
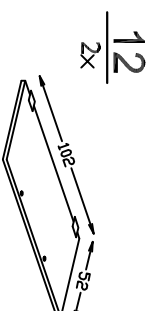
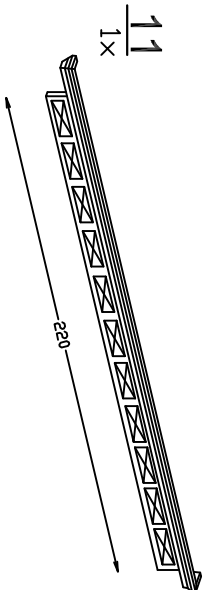
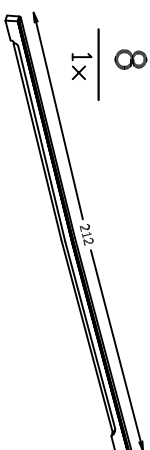
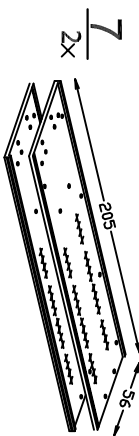
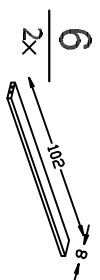
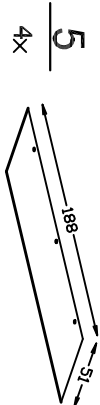
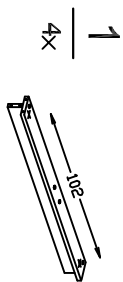



# EDENBERG 4

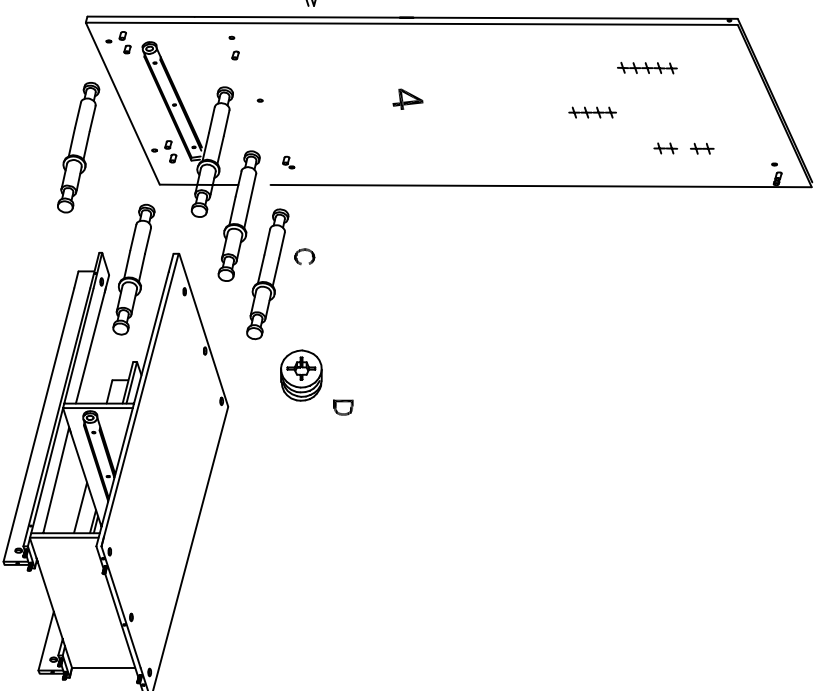
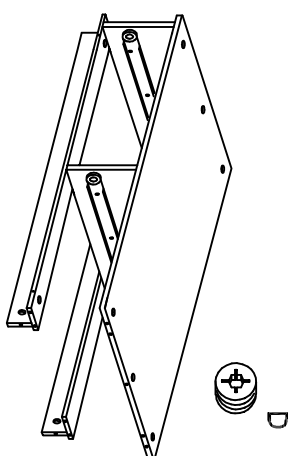
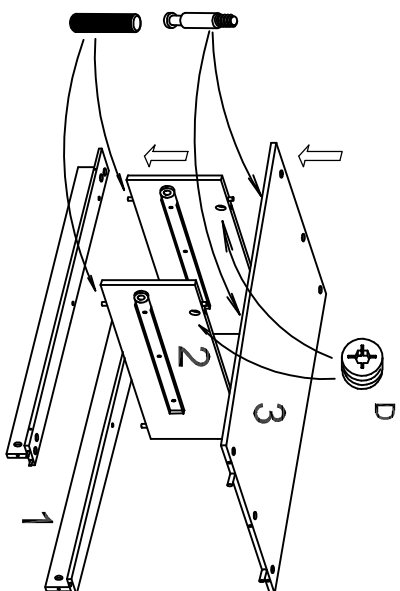

# EDENBERG 4

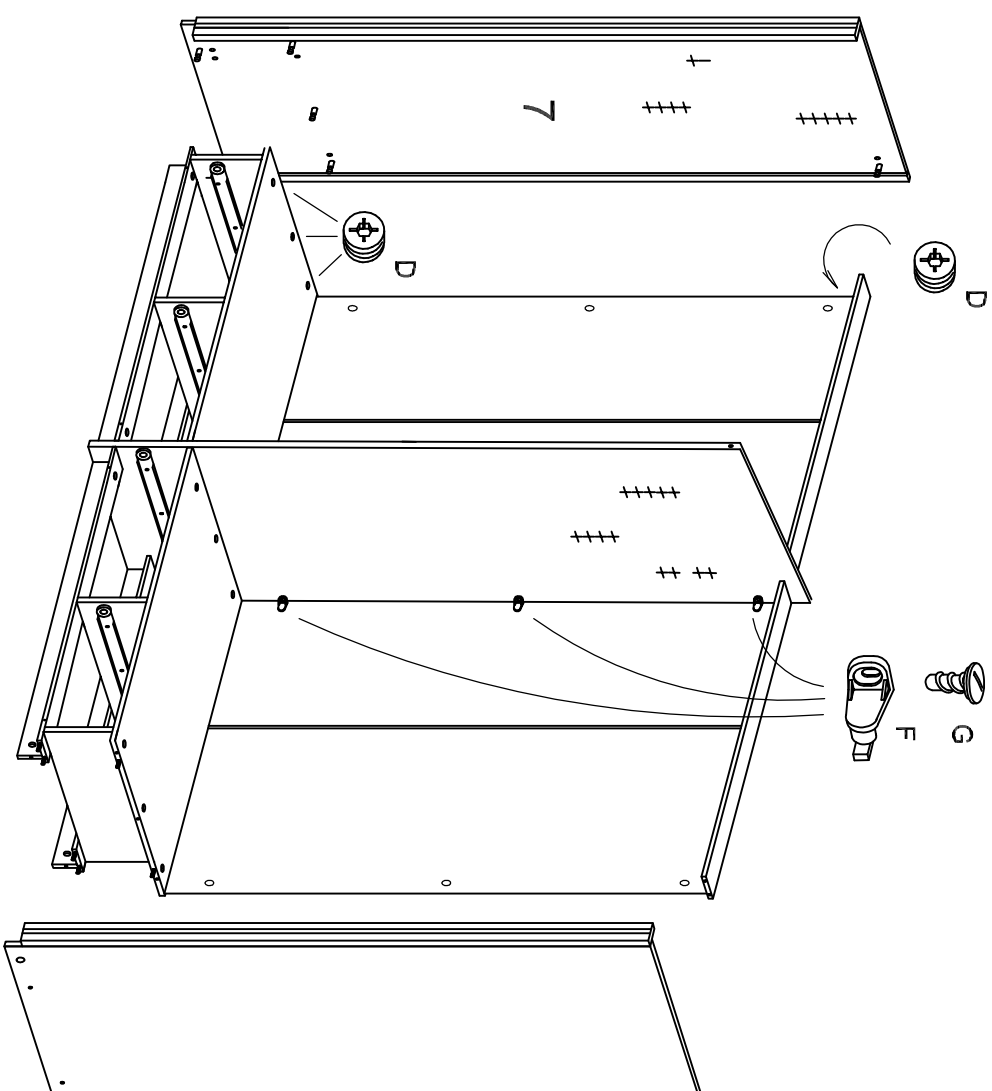
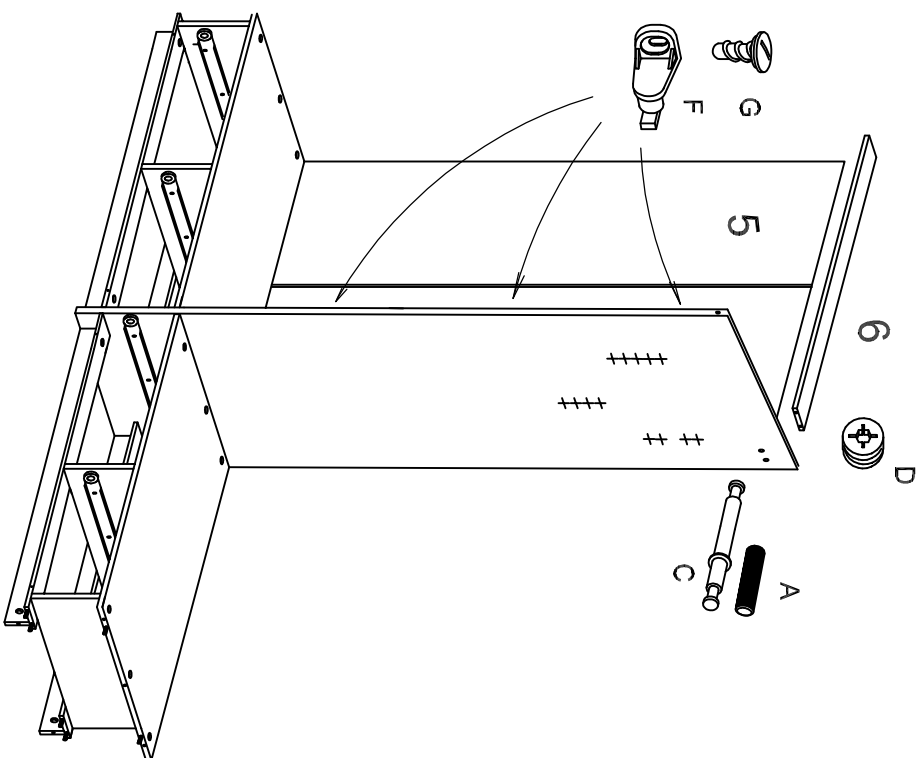

# EDENBERG 4

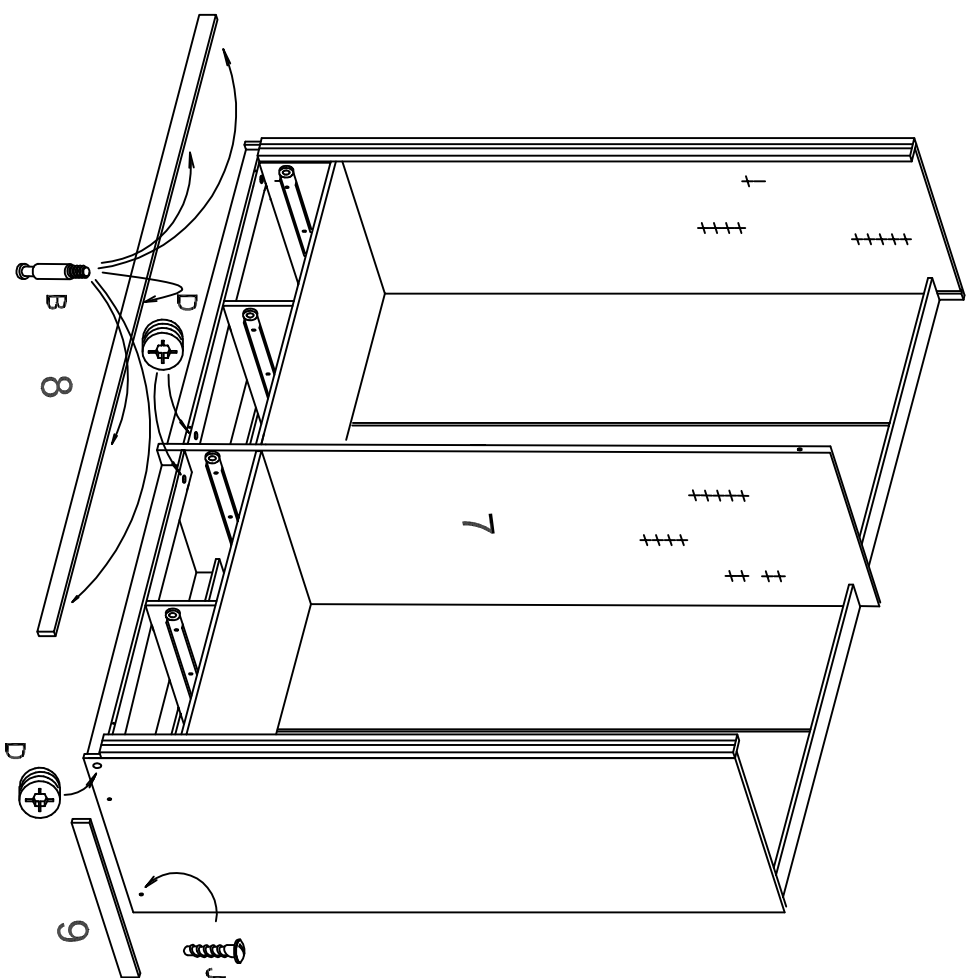

6

# EDENBERG 4

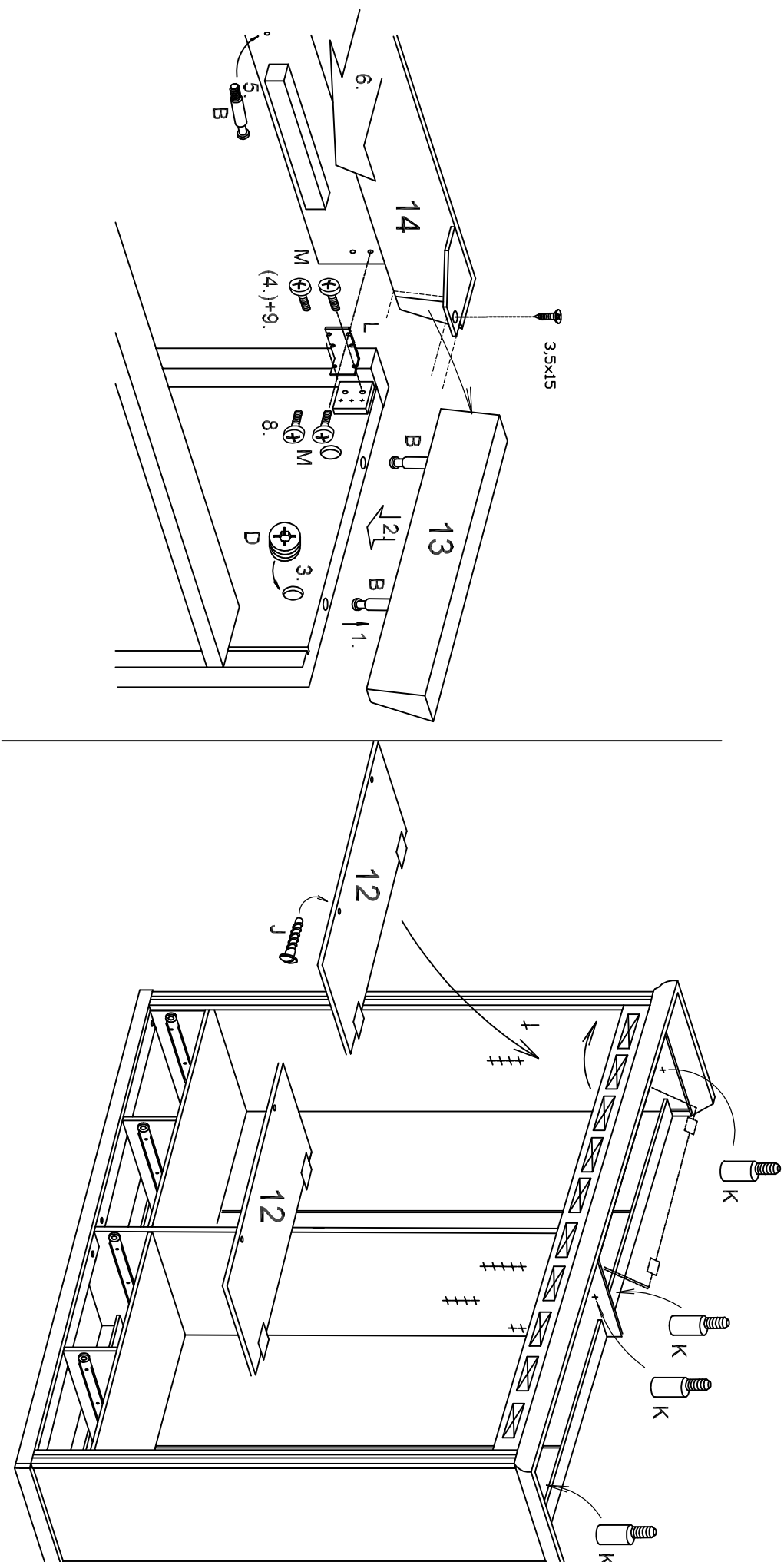

# EDENBERG 4

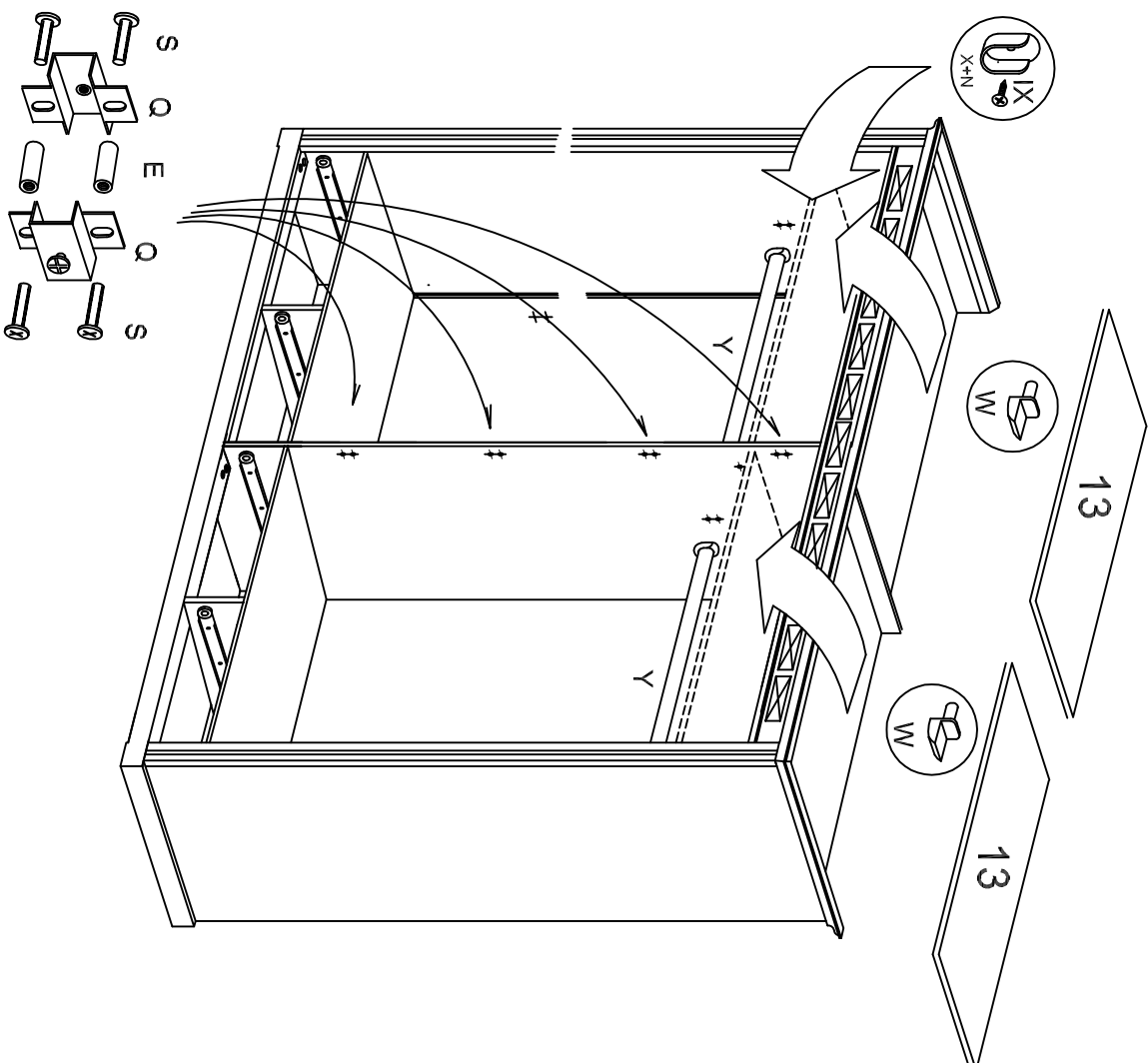



# EDENBERG 4

